

SAFETY PRIMER FEED INSTRUCTIONS

ALL BRANDS OF PRIMERS ACCEPTED

Patent # 7,694,618. Expires October 30, 2027

PRIMERS WILL EXPLODE IF SHOCKED OR CRUSHED
WEAR EYE & EAR PROTECTION AT ALL TIMES WHEN HANDLING PRIMERS

Primer dust accumulation can detonate. Regularly clean tray and tool to prevent accumulation. The dust contains lead; a substance known to cause birth defects, reproduction harm and other serious physical injury. Wash hands after exposure.

1 INSTALL primer feed bracket. Use supplied 10-24 screws.

SINGLE STAGE PRESS

2 VERIFY appropriate primer arm and trigger assembly are installed.

SMALL LARGE

3 MAKE sure trough fingers are between and completely engaged with tray latch lugs (highlighted)

4 OPEN tray and deposit box of 100 primers.

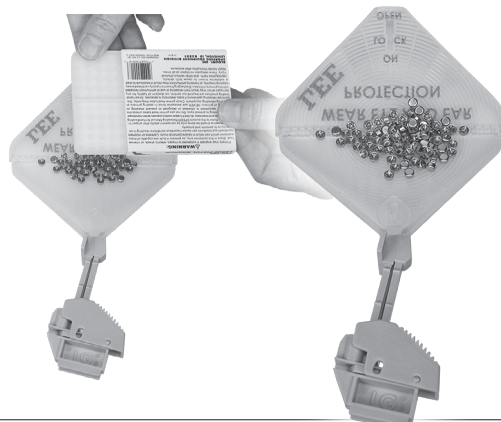
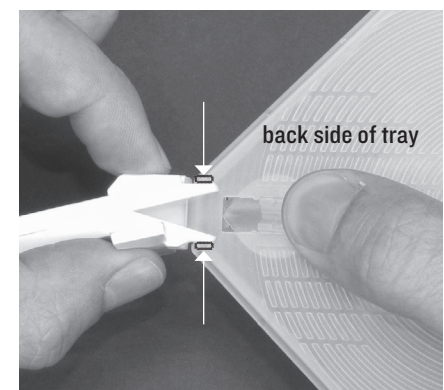

5 SHAKE tray side to side to upright all the primers. Fold and close cover and slide to ON position. Shake assembly to fill the trough.

6 SLIDE primer feed into primer feed bracket.

SINGLE STAGE PRESS

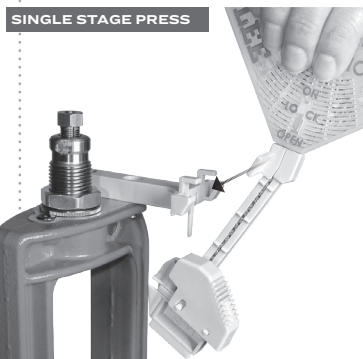
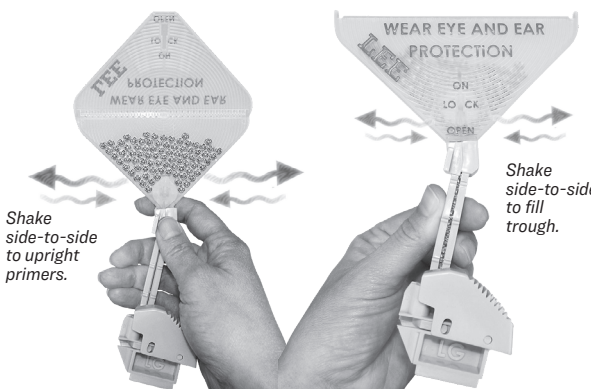

7 Firmly push trigger on the primer feed to dispense primer.

8 LOWER ram to seat primer. The primer should be flush, to slightly below flush, when properly seated.

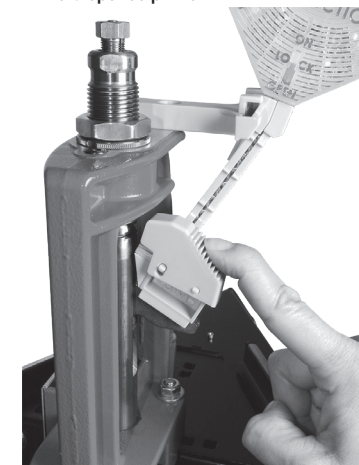

LEE
LEE PRECISION, INC. 4275 HWY. U
HARTFORD, WISCONSIN 53027
www.leeprecision.com

LEE AUTO BENCH PRIME 90700

The easiest, most convenient bench mounted priming tool ever. Effortless right or left hand operation. Includes priming assemblies for large and small primers, and you can change primer size or shell holders in seconds. Includes the new folding tray—built-in primer flipping feature allows direct filling from large primer boxes.

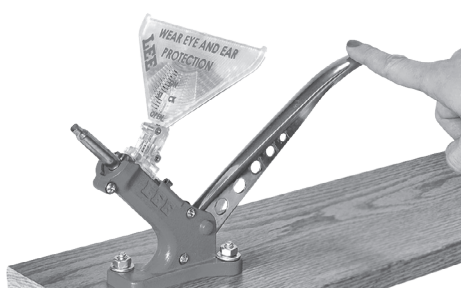

Uses the same special, but inexpensive shell holders as the hand-held New Auto-Prime & Ergo Prime.

US Patent #7,578,489
Exp. 2028

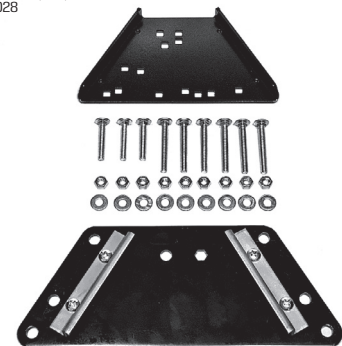

Lee Bench Plate 90251

Turns you into a quick change artist. Patented design allows instant press change. It's so sturdy you can resize the monster 50 BMG case, then quickly switch to a smaller press for priming or other operations. Trapezoidal base block slides into perfect register and is made immovable with the quick tightening of four bolts. Includes 3 base blocks; one drilled to fit all current Lee presses. Special elevator bolt hardware included. Powder coated, thick steel

mounts quickly and securely to any bench or tabletop. Wide steel plate distributes load, adding rigidity to the lightest bench top.



Lee Auto-Drum Powder Measure 90811

Automated case actuated drum powder measure. Accurately and automatically dispenses powder in your favorite cartridge. Two infinitely adjustable drums included. These Quick Change Drum will accurately and reliably drop charges from 1 to 80 grains of powder.

Lee Safety Powder Scale 90681

It is the easiest to use, most accurate and sensitive powder scale made exclusively to weigh gun powder. The Lee Safety Scale has magnetic dampening and an approach to weight lifter enclosed within its heavy metal base. The exclusive safety beam has a stainless steel razor edge for maximum sensitivity. You can be sure that the Lee Safety Scale will retain its original factory accuracy for as long as it is not physically broken.

The Lee Guarantee

LEE RELOADING PRODUCTS ARE GUARANTEED not to wear out or break from normal use for two full years, or they will be repaired or replaced at no charge if returned to the factory. Any Lee product of current manufacture—regardless of age or condition—will be reconditioned to new, including a new guarantee, if returned to the factory with payment equal to half the current retail price.

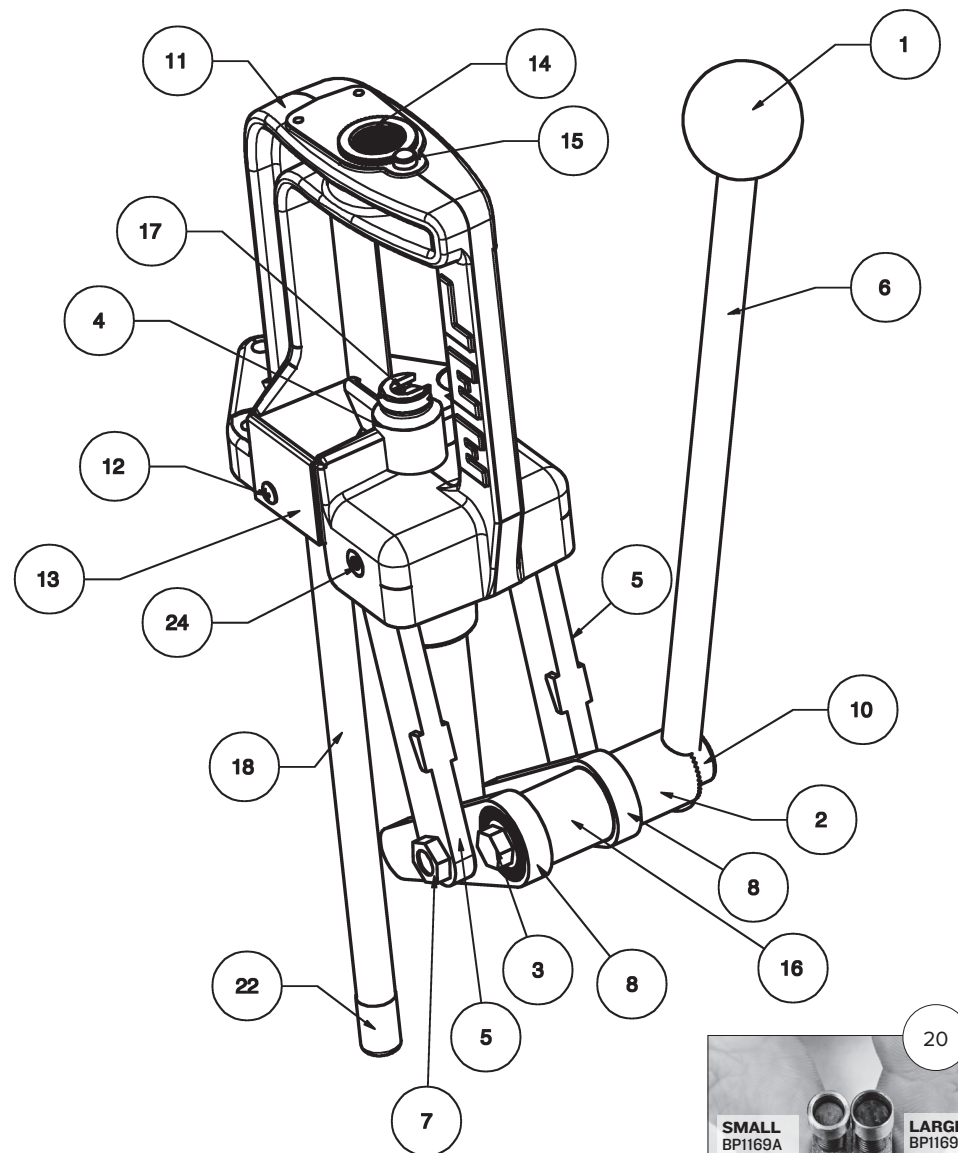

PARTS LIST

1	TR2447	Wood Knob	13	OF3606	Primer Deflector
2	BP2780	Lever Sleeve	14	OF1764	Breech Lock Bushing
3	FT3128	5/16-18x3 Bolt	15	OF3615	Retention Pin
4	BP1175	Ram	16	BP1427	Spacer
5	BP2888	Connecting Link (2)	17	TP2108	Shell Holder Retainer
6	BP3090	Lever	18	BP3064	Clear PVC Tube
7	FM1371	7/16-20 NF Nut (2)	19	BP3088	5/64 Roll Pin
8	BP2774	Toggle Link (2)	20	BP1169A BP1169B	Primer Arm Small Primer Arm Large
9	BP3000	Toggle Link Pin	21	BP1178	Instructions
10	BP2777	Lever Clamp	22	BP3127	Plastic Cap
11	BP1130	Frame	23	BP2885	Pivot Pin Thru
12	FF1428	10-24 Bolt	24	BP3313	Pivot Pin Blind

LEE BREECH LOCK CLASSIC CAST

MADE IN USA

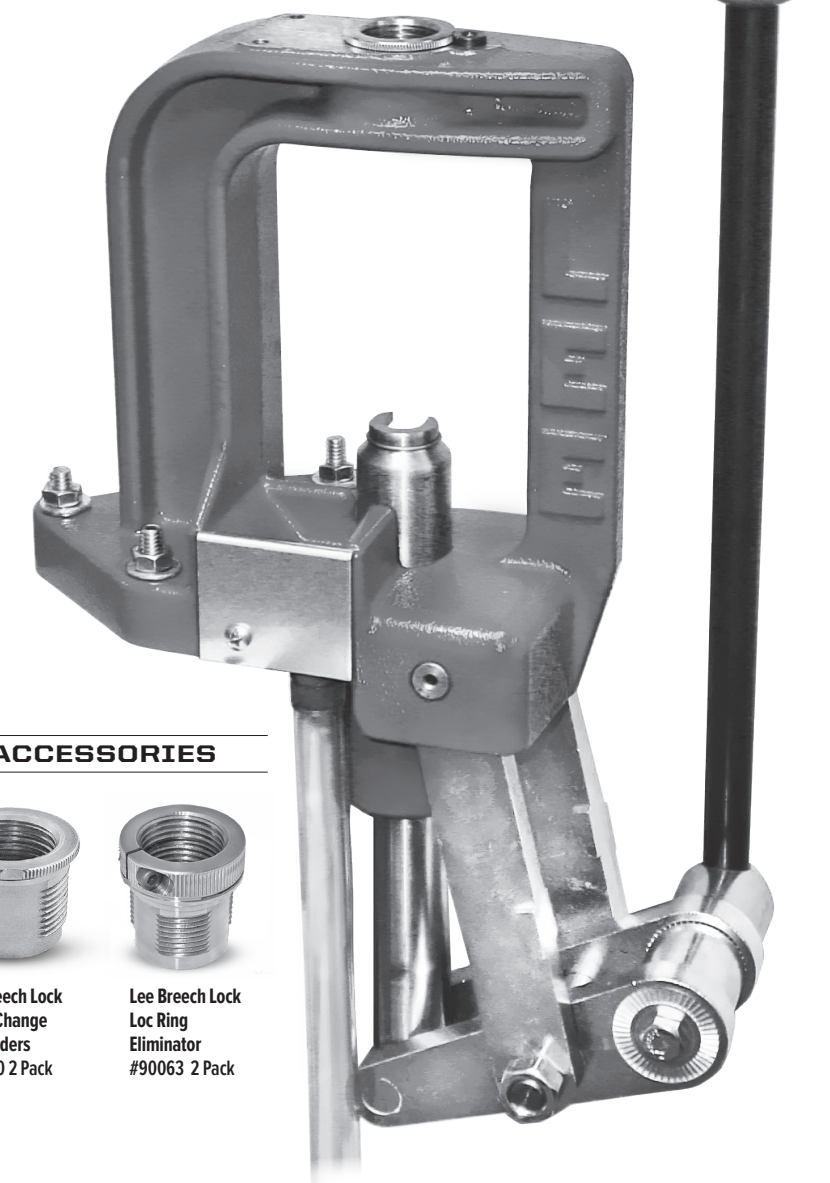

ACCESSORIES



Lee Breech Lock Quick-Change Die Holders #90660 2 Pack



Lee Breech Lock Loc Ring Eliminator #90063 2 Pack

CAUTION Ammunition reloading can be dangerous if done improperly and should not be attempted by persons not willing and able to read and follow instructions exactly. Children should not be permitted to reload ammunition without strict parental supervision. Always wear safety glasses when reloading and shooting. Ammunition loaded with these tools and data should only be used in modern guns in good condition. We do not accept responsibility for ammunition loaded with these tools or data as we have no control over the manufacture and storage of components or the loading procedure and techniques. Primers and gun powders, like gasoline and matches, can be dangerous if improperly handled or misused.



WARNING Handling live primers and spent primers may expose you to lead or other chemicals, which are known to the State of California to cause reproductive harm and cancer. For more information, go to www.P65Warnings.ca.gov.



WARNING Steel parts in this product may be alloyed with trace amounts of lead and other elements which are known to the State of California to cause reproductive harm and cancer. For more information, go to www.P65Warnings.ca.gov. To prevent exposure, do not alter the product by welding, grinding, etc.

LEE LEE PRECISION, INC.
4275 Hwy U · Hartford WI 53027
www.leeprecision.com

LEE LEE PRECISION, INC.
4275 Hwy. U · Hartford WI 53027
www.leeprecision.com

BEFORE YOU START RELOADING

SETTING UP YOUR LEE BREECH LOCK CLASSIC CAST PRESS

CONGRATULATIONS ON YOUR PURCHASE OF THE LEE BREECH LOCK CLASSIC CAST PRESS. WE DESIGNED THIS PRESS TO BE THE FINEST AND MOST CONVENIENT PRESS MADE.



1 ATTACH the Breech Lock Classic Cast Press to a sturdy bench with three 1/4" or 5/16" bolts [SEE FIGURE 1] Use the press as a template, or print a paper drill template from the INSTRUCTIONS link on our website www.leeprecision.com. For the ultimate in convenience, consider the Lee Bench Plate [CATALOG #90251]. The Lee Bench Plate, with included pre-drilled base block and necessary fasteners, allows quick removal and installation of a reloading press and adds rigidity to the lightest bench top.

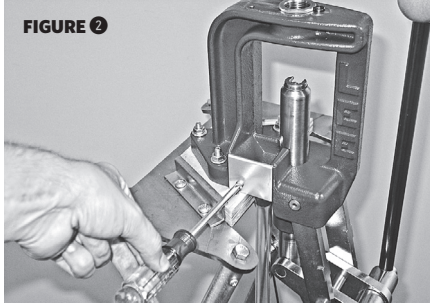

2 ATTACH the primer deflector with the provided #10-24 bolt [SEE FIGURE 2]

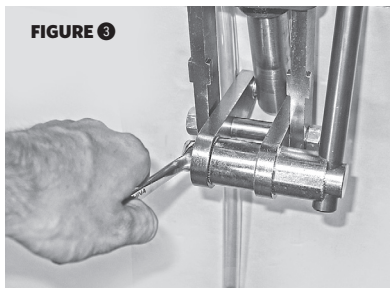

3 INSTALL the lever clamp. When sliding the lever through the lever clamp, make sure the lever passes all the way through the lever sleeve [FIGURE 3] to prevent breakage. The lever angle is adjustable by loosening the lever clamp bolt just enough to allow the teeth on the lever sleeve and toggle link to slip past one another and the lever can be installed on either side of the press for right or left handed operation.

4 SLIDE clear tube onto hose barb on bottom of the press. [FIG. 4]. Spent primers are ejected from the angled hole in ram (provided the primer arm is installed) and deposited into the spent primer trough, funneling into the clear tube. There is a cap on the end of the tube to allow for convenient disposal of spent primers, or the tube can be routed directly into a trashcan.

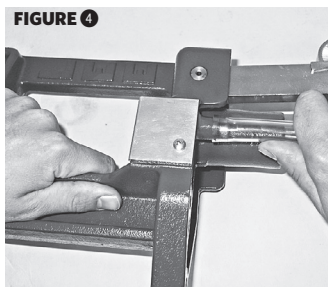

Your press features the Lee Breech Lock Quick-Change Die Holders



Thread your die into a quick-change holder and lightly snug the lock ring

Once your dies are set you can instantly remove them and replace them to the exact same position. The Breech Lock Classic Cast Press includes a lock pin for initial die set up. If cost is more important than convenience, you can leave the Breech Lock bushing permanently installed and screw your dies in and out as in any conventional press.



Insert the holder into the press so that the lock groove will line up when secured. Adjust your die in or out for proper operation.



Remove the die by depressing the lock pin; rotate die 1/6 of a turn. Lift out and change to your next die. After your dies are set, they can be installed so that the lock groove does not line up with the lock button.



Notice how the lock pin is automatically depressed, allowing instant one-handed removal.

IT IS YOUR RESPONSIBILITY TO ENSURE THE SAFETY OF YOUR LOADS

THE FOLLOWING ARE FACTORS THAT WILL INCREASE PRESSURES. SOME WILL BE DANGEROUS.

- DO NOT USE more powder than recommended
- DO NOT USE a heavier bullet than recommended
- DO NOT SEAT the bullet deeper than normal
- DO NOT USE magnum primers unless using a slow burning ball powder
- Greatly oversized bullets, excessively hard bullets or cases that are too long will cause higher pressures
- High temperatures, or cartridges stored in a hot car or car trunk produce higher pressures

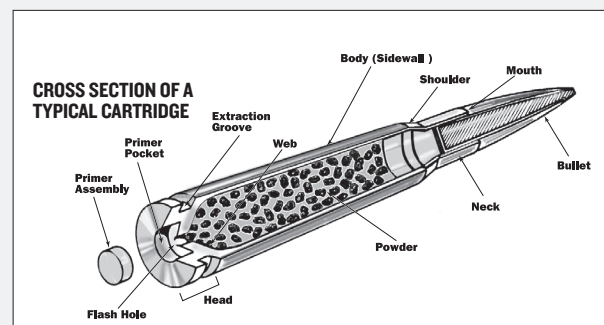

RELOADING IS QUITE A SIMPLE PROCESS

- 1 Case is sized to original dimensions and the spent primer is removed
- 2 Install a new primer
- 3 Add a charge of powder
- 4 Seat a new bullet and crimp if desired

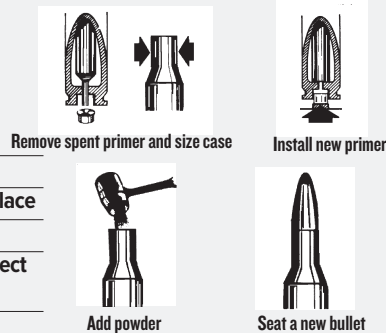

RELOADING SAFETY

Keep powder away from heat and open flames — Don't smoke

Store powder and primers in their original containers in a cool, dry place

Read and follow instructions exactly

Be sure you have the correct powder, measure and bullet of the correct weight. Any mixup can be dangerous

Exercise care and common sense at all times

WEAR SAFETY GLASSES WHEN RELOADING OR SHOOTING

CASES The easiest and best way of getting cases is to simply save those from your factory loaded rounds. New and used cases can also be purchased. Cases must be clean and safe. Do not use cases that have cracks or splits. If they have been used more than twice, they should be checked to see that none of them have become too long for safe use. The easiest way is to trim them with a LEE CASE TRIMMER. This automatically cuts them to the correct length and no gauging or measuring is needed. After trimming, be sure to chamfer both the inside and outside of the case. A LEE CHAMFER TOOL works best, but it can be done with a pocket knife.

Straight sided cases, such as those used by most handguns, are loaded with a 3-die set.

MILITARY CASES Used military cases are readily available at low cost. Usually, these have primers that are crimped in place. This is to prevent the primer from coming loose in automatic weapons and jamming the action at an inopportune time. The crimp must be removed before repriming. This can be done with a primer pocket reamer or swaging tool. Even a LEE CHAMFER TOOL can be used to ream the crimp.

POWDER Powder is usually classified as smokeless and black powder. There is also Pyrodex, which is a substitute for black powder. We will be using only smokeless powder for reloading.

Each set of Lee Dies is supplied with powder measure and charge table with a generous selection of loads. Additional load data is available from all the powder manufacturers and bullet makers. This is excellent information and should be followed exactly.

Different powders are available to do different jobs. Bullets having a high sectional density (long length in relation to their diameter) require a slow burning powder. This permits sustained peak pressure to gain maximum acceleration within working pressure limits. Short, light bullets use quicker burning powder for complete combustion within the barrel. A wide selection of powder is readily available. Powders should always be stored in their original containers. While

smokeless powder is not an explosive and not as dangerous to handle as gasoline, it would be foolish to handle it carelessly and store excessive amounts. Follow the powder manufacturers' recommendations for storage and use.

PRIMERS Rifle and pistol cartridges require different primers. Rifle primers have a thick and stronger cup to withstand the higher pressure. Pistol primers have a thinner cup for easy detonation with a lighter hammer blow. Both rifle and pistol primers are available in regular and magnum. Use regular for all loads except if the load data specifies magnum primers.

Primers must always be stored in their original containers. It is always a wise idea to wear safety or shooting glasses when shooting or reloading.

BULLETS Commercial rifle bullets usually have a soft lead core with a copper jacket. Point shapes come in a variety of styles, but usually have some soft lead exposed to properly mushroom on impact.

The jackets serve a dual purpose: to control the bullet expansion and act as a bearing surface for its high speed travel down the bore. Some bullets have a crimping groove called a cannelure. This groove must be seated almost entirely in the case when crimping the case. The very end of the case mouth is turned into this groove by the bullet seating die used in a tubular magazine gun and most revolver ammunition.

Cast bullets are very popular with the handloader. They are very economical to use and can be as accurate as jacketed bullets. They do not normally expand as well as soft lead jacketed bullets on game. Therefore, it is poor economy to use them for hunting.

CRIMPING Ammunition loaded for hunting should always have the bullets crimped in place, as should ammunition used in tubular magazine and auto-loading rifles. It could ruin your hunt if a bullet wedged in the chamber or pushed back into the case. Best accuracy is usually obtained with crimped ammo as the crimp has an effect on ignition, velocity, pressure and ballistic consistency. No die does a better job crimping than the patented LEE FACTORY CRIMP DIE.

YOU CAN NOW BEGIN RELOADING

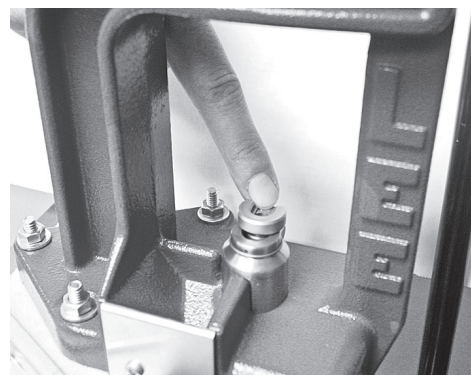

1 INSTALL SHELLHOLDER AND APPROPRIATE SIZE PRIMER ARM

Insert the primer arm so the notch in the bottom of the primer arm engages with the cross pin in the ram. As you lift the lever all the way up (lower the ram), the primer arm tips vertical and aligns with the hole in the center of the shellholder. As the lever is lowered, the primer arm drops down and tips back out. Cycle the press lever a few times to familiarize yourself with the lever prime mechanism. **NOTE** Primer arm must be installed to allow proper function of the spent primer collection system.

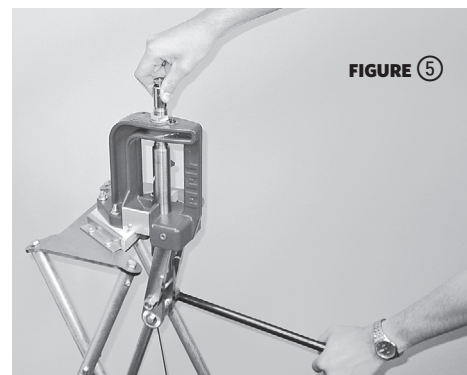

2 SIZING DIE ADJUSTMENT While holding the lever all the way down against the stop, insert sizing die with breech lock bushing installed into press frame and turn the sizing die until it touches the shellholder (FIGURE 5). Raise the lever (lower the ram) and turn the die in an additional 1/4 to 1/2 turn. **NOTE** Carbide dies should not be turned in the additional 1/4 to 1/2 turn.

Lower the lever again, and use the ram to apply light pressure to the base of the die. This will keep the die from turning as one tightens the lock ring to secure the adjustment just made.



3 PREPARE YOUR CASES If using a steel sizing die, it is necessary to lubricate your cases. This is also a good time to inspect cases for split necks, indications of head separation or other defects. Apply a thin film of LEE CASE RESIZING LUBRICANT (CATALOG #90006) with your fingers. This method will allow you to detect any grit that may be clinging to the case, which would scratch the sizing die if not removed. The case may be sized immediately or allowed to dry.



CAUTION

If for any reason you do not use Lee Resizing Lubricant, be very careful not to contaminate the powder or primers. All other brands are oil based and have serious, detrimental effects on powder and primers. Because of the stickiness, they also attract grit that can damage the die. Lee Resizing Lubricant costs less and is so superior that it is worth the effort to insist upon it or order direct from the factory.

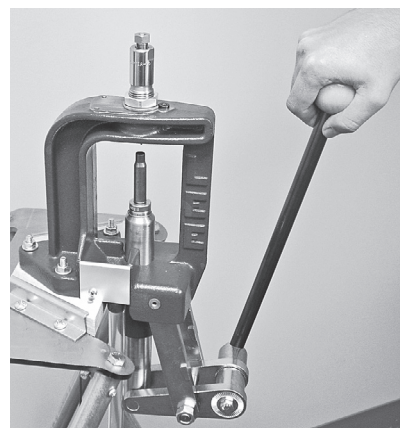

4 RESIZE THE CASE Place the cartridge case in the shellholder and raise the ram until the shellholder contacts the base of the die. It is important to verify that the shellholder contacts the base of the sizing die when resizing the cartridge case. This establishes correct headspace.

5 PRIMING YOUR CASE THE BREECH LOCK CLASSIC CAST PRESS includes two primer arms, one each for large and small primers. With appropriate size primer arm installed, place correct size primer into the cup on the primer arm (FIGURE 6). Slowly approach the end of the stroke so you can feel the slight resistance as the primer is pressed into the case. Lift hard enough on the lever to seat the primer flush or slightly below flush. Using the LEE SAFETY PRIME SYSTEM (CATALOG #90997) greatly speeds up this operation. See panel on reverse for details on the Lee Safety Prime System. If you prefer off press priming, an excellent choice is the LEE AUTO PRIME XR®. The Lee Auto Prime XR® is a fast, safe and effective way to prime cases.

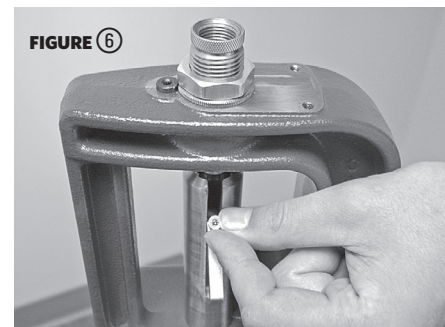

6 FLARING THE CASE MOUTH

Most handgun cartridges should have their mouths flared to allow easy bullet seating with out shaving. This flaring or expanding die is standard in most LEE PISTOL DIE SETS. The Lee die features a hollow expander plug allowing you to expand and charge the case simultaneously. An AUTO-DISK POWDER MEASURE may be installed on top of this die.

This operation is usually omitted on bottleneck rifle cartridges. See instructions included with your die set for proper adjustment.

Lee offers a UNIVERSAL CASE EXPANDING DIE (90798), usable with most rifle and handgun cartridges. Works great

to prevent shaving of cast lead bullets or moly and low friction coatings found on high performance jacketed bullets.

7 CHARGE THE CASE WITH POWDER

Regardless of how you charge the case, be absolutely certain that you have the correct type and amount of powder for the bullet you have selected. We have several tools for dispensing powder. All LEE DIE SETS (except the RGB SERIES) include a dipper for measuring powder and load data. For reloading rifle cartridges, the PERFECT POWDER MEASURE would be a fine addition to the Breech Lock Classic Cast Press. For pistol cartridges we recommend the AUTO DISK POWDER MEASURE. When used with LEE PACESETTER DIES, the Auto Disk Powder Measure threads into the Powder Thru Expanding Die, so the cartridge case is flared and powder charge is added simultaneously.



8 BULLET SEATING Adjust the BULLET SEATING DIE per the instructions included with your die. Place a bullet on the case mouth and guide it into the die. Raise the ram to the top and withdraw. The knurled adjusting screw controls the bullet seating depth. Adjust to suit. Usually, seating to the same depth as a factory round works fine. If you desire to crimp, be sure the bullet crimp groove is almost completely inside the case. Then screw the die body in just enough to apply a good crimp. Attempts to apply excessive crimp will crush the case. For proper crimp all cases must be trimmed to the same length. For best utility and accuracy, consider the LEE FACTORY CRIMP DIE. You will never crush a case; no crimp groove is required and trim length is not critical.



9 FINAL CHECK Check your reloaded cartridges for any signs of defects. If there is any doubt about the quality or correctness of a reloaded cartridge, dispose of it properly. Do not take an unnecessary chance on questionable ammunition. If loading maximum loads, it is good practice to remove case lubricant with detergent and water. This will reduce pressure against the bolt.

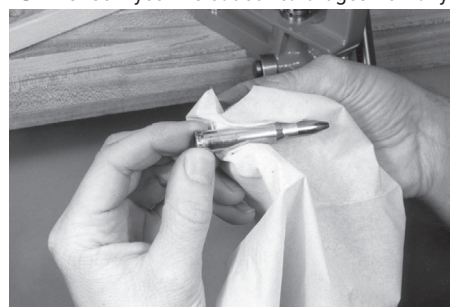

10 PROTECT YOUR INVESTMENT Ensure that your press will look and function the same as the day you purchased it. Lubricate the ram and all the pivot points on the press lever linkage. The connecting links can be lubricated through the pivot pin on either side. Nearly any lightweight oil can be used. Avoid water displacing oils such as WD-40. Treat your press like a fine firearm; leave a film of oil on uncoated metal parts at all times.

LEAD WARNING

Primers contain lead: a substance known to cause birth defects, reproductive harm and other serious physical injury. Wash hands after exposure.